











33 816 875



- saillie 241 mm
- bec pivotant 360°
- jet enrichi en air
- hauteur de robinetterie 393 mm
- hauteur jusqu'au mousseur 240 mm
- diamètre de percement 35 mm
- débit d'eau maxi. 8 l/min avec une pression d'écoulement de 3 bars
- sans plomb
- Ce produit contribue au respect des exigences des systèmes d'évaluation des bâtiments écologiques, par exemple LEED®, BREEAM®, DGNB

	Platine brossé	33 816 875-06
	Chrome	33 816 875-00
	Platine	33 816 875-08
	Laiton (Or 23cts)	33 816 875-09
	Dark Chrome	33 816 875-19
	Laiton brossé (Or 23cts)	33 816 875-28
	Noir mat	33 816 875-33
	Champagne brossé (Or 22cts)	33 816 875-46
	Champagne (Or 22cts)	33 816 875-47
	Chrome brossé	33 816 875-93
	Dark Platinum brossé	33 816 875-99

Accessoires recommandés

Commande de vidage individuelle manuelle 10 712 970-06
Commande manuelle - Platine brossé



Accessoires recommandés

Distributeur sans rosace - Platine brossé 82 424 970-06



33 816 875



Diagramme de débit



Certificats

GDV_0400195.

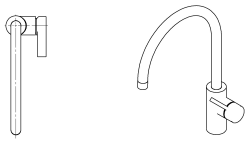
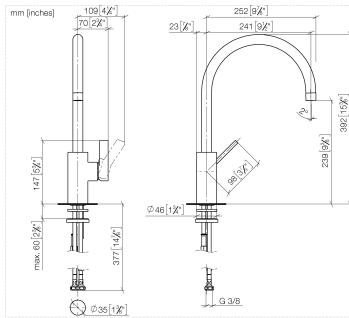
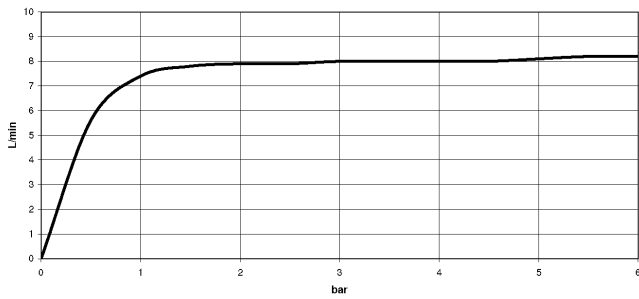
LGA_18899.

WRAS_2101012.

ETA_18980.

33 816 875

Les pièces pour les autres finitions peuvent être trouvées ici : [Chrome](#)

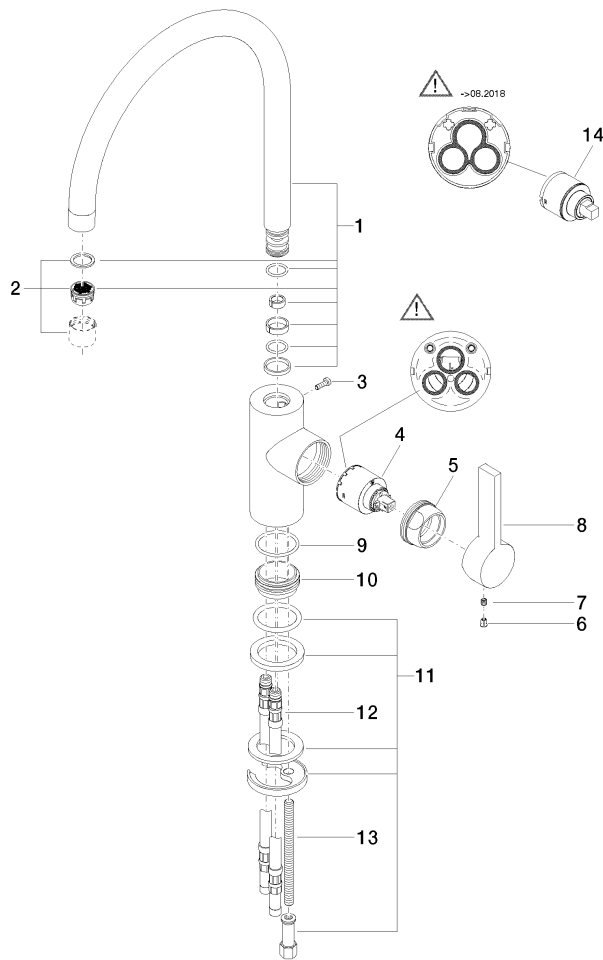

Liste des pièces de rechange

N°	Article Numéro	Désignation	Fréquence de montage	Délai de livraison
1	90 28 22 202 02-06	bec déverseur	1	10
2	90 23 01 004 07-06	mousseur	1	10
3	09 30 30 080 90	vis	1	2
4	90 15 05 061 00 90	cartouche	1	60
5	09 24 04 107-06	écrou	1	10
6	09 31 20 017 90	bonde de fond	1	2
7	90 31 11 030 00 90	tige	1	2
8	09 20 79 040-06	poignée	1	10
9	09 14 10 119 90	joint	1	2
10	09 28 10 109-07	anneau	1	30
11	04 30 11 085 88 90	set de fixation	1	2
12	04 30 04 016 00 90	flexible	2	60
13	09 31 11 012 90	tige	1	2
14	90 15 05 045 00 90	cartouche	1	2